

Mini Coax+ modules (surface mount, SMT/SMC)

Page

Mini Coax+ connector system – general information	09.02
Technical characteristics	09.03
Mini Coax+ straight modules for backplane assembly	09.04
Mini Coax+ angled modules for daughtercard assembly	09.05



The Mini Coax standard connector system is now further enhanced with the **Mini Coax+**. This new connector system has been originally developed for 3rd generation telecom base stations. Excellent transmission characteristics are realised by the lowest connector losses and matched impedances of all internal sections. The Mini Coax+ connector therefore offers best transmission characteristics for RF signals up to 4 GHz.

The modules are available in metric size 1.00 SU (SU = System Unit = 25 mm) with 2 to 6 coaxial lines. Mini Coax+ combines the advantages of both reflow soldering principles SMC and SMT. SMC stands for

'Pin in Hole' and therefore provides high mechanical strength and endurance against dynamic and static shearing forces. SMT stands for 'Pin on Pad' and therefore provides highest RF performance of board terminations (see Fig. 1). Both principles allow fully automated assembly which promotes HARTING's multi coax connector to a product which offers an all in one solution:

- Fully automated board assembly
- Robust design
- Excellent RF performance

signal termination SMT

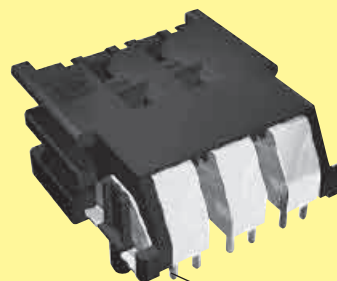
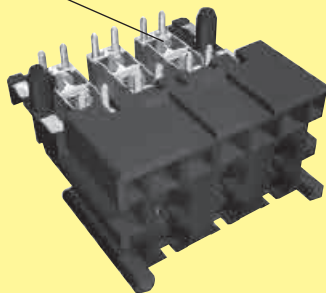

Fig. 1: Angled Mini Coax+ module

ground termination SMC

Based on available SPICE models for the connector customers' design-in can be supported by HARTING's in house RF competence centre with close co-operation. This guarantees optimised signal transmission in the target application. On this behalf our vision is to support the customer from the design-in phase to a real running application.

Mini Coax+ connectors are full mating compatible to standard Mini Coax connectors and offer a constant mating depth compared to product line *harbus* **HM+**. Therefore a simultaneous use on one board is possible in any mixed configuration (see Fig. 2).

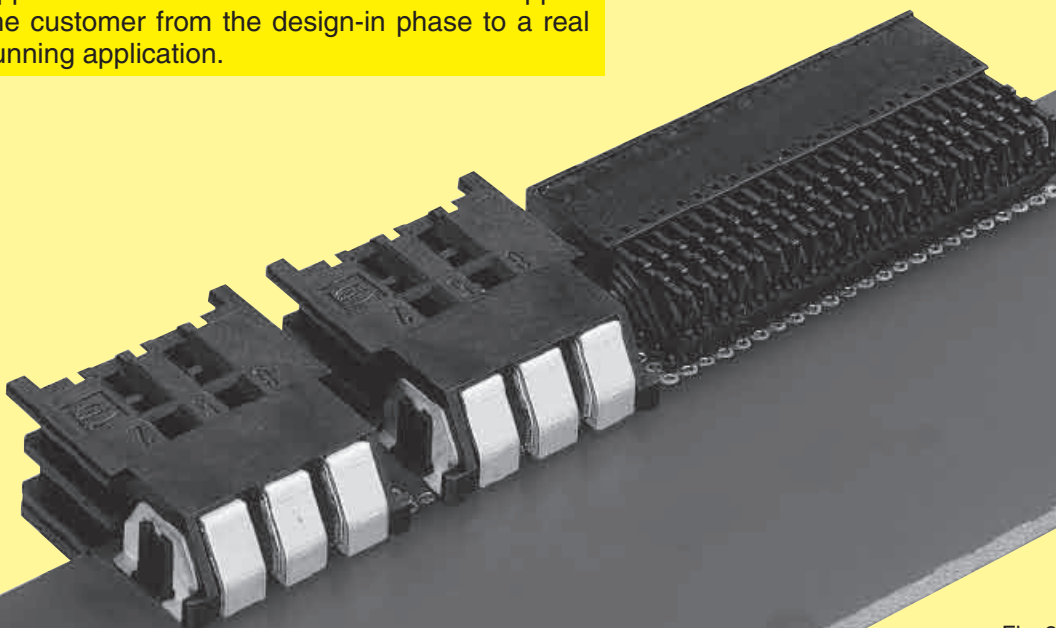

Fig. 2: Board with mixed connector configuration

Number of contacts	:	2, 4 or 6 coaxial contacts
Grid pattern	:	4.40 x 6.25 mm (within a twin x between twins)

Dielectric withstanding Voltage $U_{r.m.s.}$:	≤ 450 V (for 60s)
DC-contact resistance		
Centre contact	:	≤ 15 m Ω
Ground contact	:	≤ 6 m Ω
Insulation resistance	:	≥ 5000 M Ω

Nominal impedance	:	50 Ω
Frequency range	:	0 – 4 GHz
Return loss*	:	≥ 20 dB ¹⁾ (0 ... 2.5 GHz) equal to VSWR ≤ 1.22 ≥ 20 dB ¹⁾ (0 ... 4.0 GHz) equal to VSWR ≤ 1.22
Insertion loss	:	≤ 0.23 dB ¹⁾ (0 ... 2.5 GHz) ≤ 0.75 dB ¹⁾ (0 ... 4.0 GHz)
Crosstalk attenuation	:	≥ 50 dB ²⁾ within a twin (0 ... 2.5 GHz) ≥ 60 dB ²⁾ between twins (0 ... 2.5 GHz) ≥ 35 dB ²⁾ within a twin (0 ... 4.0 GHz) ≥ 45 dB ²⁾ between twins (0 ... 4.0 GHz)

Mating cycles	:	max. 500
Termination technique	:	Surface Mount Technology (SMT / SMC)
Mating compatible	:	Mini Coax Standard modules
Mating force	:	≤ 5 N/line
Withdrawal force	:	> 1 N/line
Mating distance	:	12.5 ... 15 mm
Wiping length	:	2.5 mm
Acceptable radial mating offset:		max. ± 1.5 mm

Temperature range	:	-55 °C ... $+125$ °C
Reflow temperature	:	220 °C for 2 minutes, 260 °C max.

Moulding material	:	Liquid Cristal Polymer (LCP), UL 94-V0
Contact surface		
Contact zone	:	Au

Note: Measurements with development samples of the straight Mini Coax+

* Reference: short contact

¹⁾ Data of a separate Mini Coax+ mated connector pair including the microvias of pcb

²⁾ Data of Mini Coax+ connector pair including the whole test board environment

Available
on request



Straight modules

Identification	Number of contacts	SU	loaded positions	Part number
Mini Coax+ modules, SMC termination	6	1	2, 5, 8	07 11 100 0027
	4	1	2, 8	07 11 900 0032
	2	1	2	07 11 900 0031

Dimensions

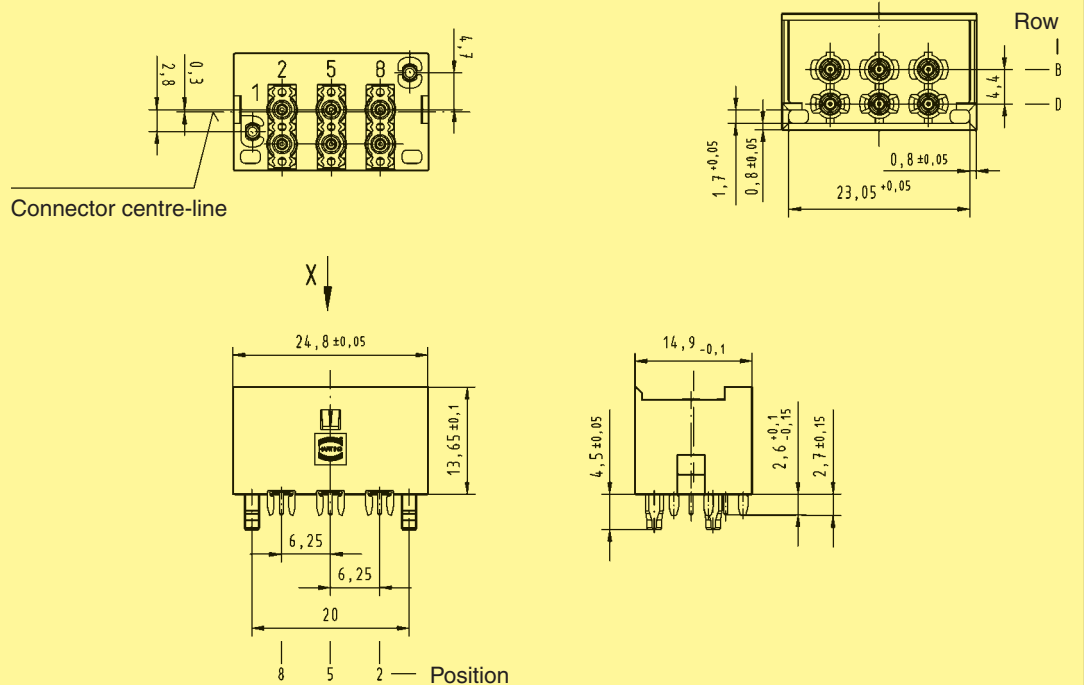

Board drillings

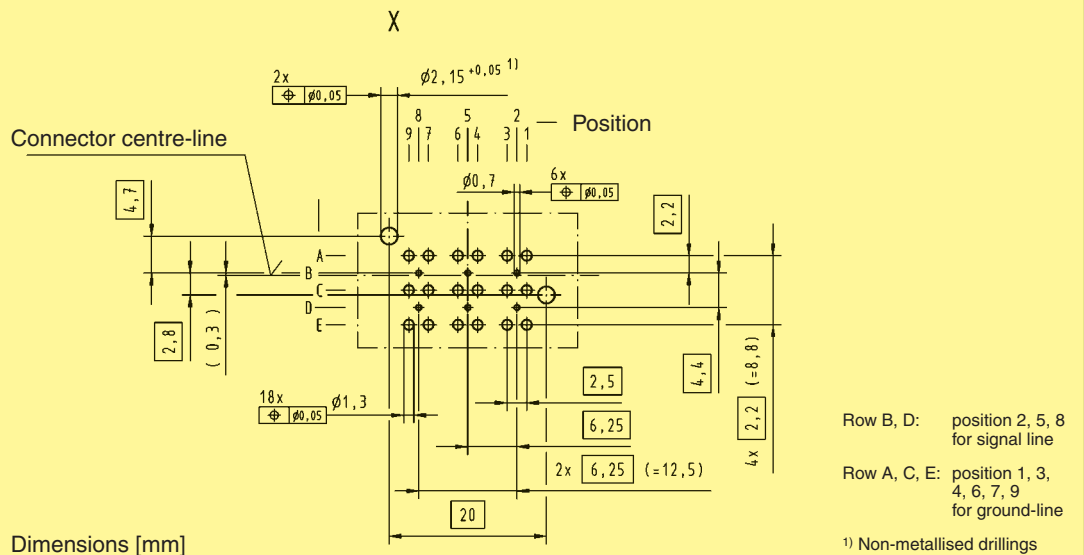

Available
on request

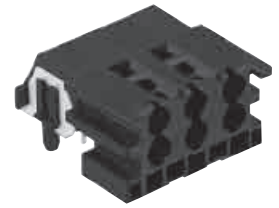

Angled modules

Identification	Number of contacts	SU	loaded positions	Part number
Mini Coax+ modules, SMT / SMC termination	6	1	2, 5, 8	07 31 100 0023
	4	1	2, 8	07 31 900 0032
	2	1	2	07 31 900 0031

Dimensions

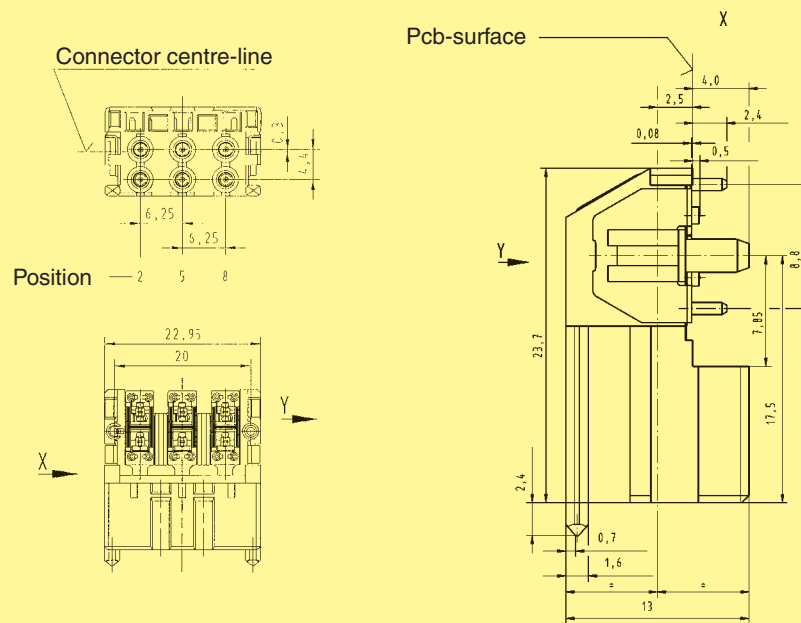

(View magnified)

Board drillings

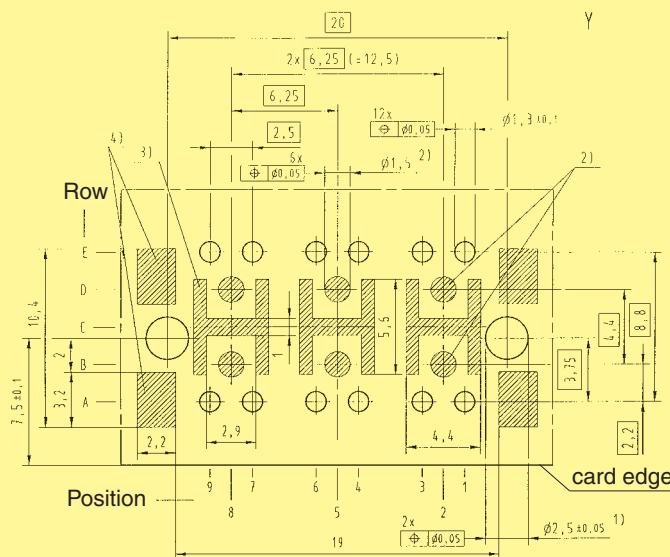

Row B, D: position 2, 5, 8 for signal line

Row A, C, E: position 1, 3, 4, 6, 7, 9 for ground-line

1) Non-metallised drillings

2) Solder pad for signal-line

3) Solder pad for ground-line

4) Solder pad for fixing anchor

Dimensions [mm]

